

EXAMION®

X-Ray Systems · Digital Imaging · Service

EXAMION X-ray systems

Individual solutions for your individual needs



EXAMION GmbH

EXAMION is a specialist provider of digital radiography solutions dedicated to human and veterinary medicine, based in Germany. We offer a large portfolio of digital X-ray systems and services for veterinary practices and medical clinics. For more than 30 years now, we have been committed to the provision of future-oriented solutions in the areas of digital X-ray systems, software and support services especially designed for veterinary practitioners.

In addition to controlling our X-ray systems, our innovative X-AQS software also includes diagnostic viewing, evaluation, and archiving functions for all medical image data.

EXAMION presently serves more than 7,000 installations. We continuously evaluate the needs of the specific market segments and adapt our business activities accordingly.

We support our customers throughout from planning and project management to expert installation and comprehensive service support.



More than 30 years of experience and expertise in digital X-ray systems

EXAMION's successful business history began in 1989, and since then it has continued to consolidate its leading position as an innovator in its field. Our many years of experience make us a trusted partner for all your digital X-ray system needs.



Forward-looking

Our EXAMION systems are entirely integrated solutions involving hardware and software components. We put particular importance on hardware durability. Also, our patented EXAMION X-AQS X-ray software is persistently developed. This allows us to provide the constant advances in IT technology and guarantee straightforward operation of our consistently updated software with each new generation computers.

Customer-oriented

Given our commitment to the 'One Stop Shop & Service' principle, EXAMION has its own national representatives and a strong service network. A personal representative is available. In the case of technical support requests, we strive to provide a swift and efficient solution, connecting you with expert engineers. EXAMION operates internationally through its own subsidiaries and a worldwide range of certified sales and service partners..

Innovation

EXAMION development, sales, and services are closely linked in house. Since we also uphold close contact with our customers, their needs can be integrated directly in the development process. This enables us to develop solutions that contain multiple functions with fast and intuitive operation. Our pioneering approach has led us to effectively advance the existing limitations with different individual systems and integrating the previously separated functions within a single operating system. The EXAMION X-AQS software combines the tasks of image acquisition, diagnosing and image archiving under a unified, modular concept.

Quality awareness

EXAMION is committed to uphold the highest quality standards. Our company has a quality management system according to ISO 13485. This standard is particularly intended for the design and manufacture of medical devices. Our processes based on this standard are constantly monitored through internal and external audits. The core process is based on standardized product assembly and subsequent comprehensive quality controls.



Value for money

EXAMION X-ray systems offer a superior price-quality ratio. Due to the wide range of systems and the diversity of configuration choices, EXAMION customers only buy the modules they really need. Please contact us for more details, we will be happy to assist you.

-R X-ray systems – overview

Advantages of EXAMION X-ray systems

Optimised workflow and minimum throughput time per X-ray exposure due to:

- Reliable detector technology
- Common control of system components via EXAMION X-AQS software
- Intuitive software design

Maximum image quality due to:

- High-quality EXAMION detectors
- State-of-the-art image processing



Why purchase an X-ray system from EXAMION?

We offer a range of digital X-ray solutions suitable for individual practitioners who are starting out with just a few examinations per week, or for well-established veterinary practices or clinics with a high volume of examinations.





EXAMION offers both stationary equipment, as well as portable X-ray systems for use off-site, suitable for difficult conditions or emergency situations.

Areas of application

Our systems are most commonly used in the following settings

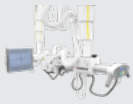
- Small animal veterinary practices
- Small animal clinics
- Mobile equine veterinary practices
- Dedicated equine veterinary clinics

Naturally, we also offer solutions for specialised applications, including birds, fish, wild or exotic animals. Our systems are also used in zoos and university teaching and research settings.

		Small animal veterinary practices	Small animal clinics	Mobile equine practices	Equine clinics
X-DRS Ceiling					
X-DR Static Classic					

Your expert partner for X-ray systems



		Small animal veterinary practices	Small animal clinics	Mobile equine practices	Equine clinics
X-DRS Floor Basic			X		
X-R Static Univet		X			
X-R Portable 20 BT				X	X
X-R Portable 20 BT Plus				X	X
X-R Portable 40 BT		X		X	X
X-R Portable 20 Plus				X	X
X-R Portable 40		X		X	X
X-DR Portable Case M WiFi DT		X		X	X
X-DR Portable Case L WiFi		X		X	X
X-R Static Dental HF wall / mobile		X	X		
X-CR More Tabletop FireCR Dental		X	X		
X-CR systems		X	X		

X-ray gantry system for equine clinics

Our complete X-ray gantry system with its extensive functions is specially designed for professional radiographic examination of horses. Well-designed X-ray generators provide enough power to penetrate even the dense thickness of the horse's torso. Ceiling-mounted telescopic arms hold the X-ray generator, eliminating the need for the X-ray operator to manually carry the weight of an X-ray machine. This system combines high performance with maximum ease of use.

Your expert partner for X-ray systems

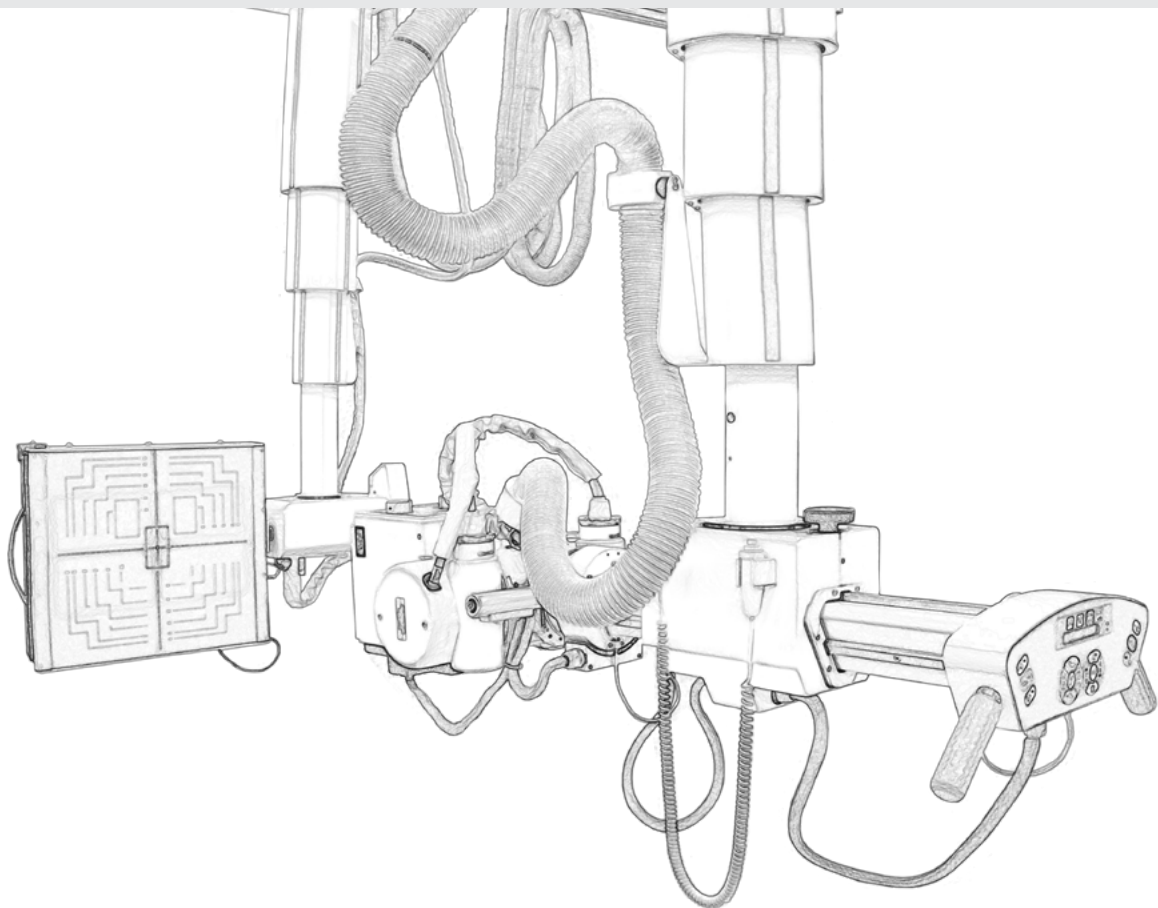

X-DRS Ceiling Systems

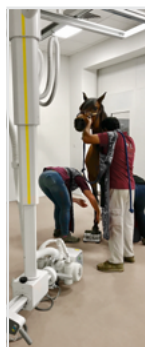
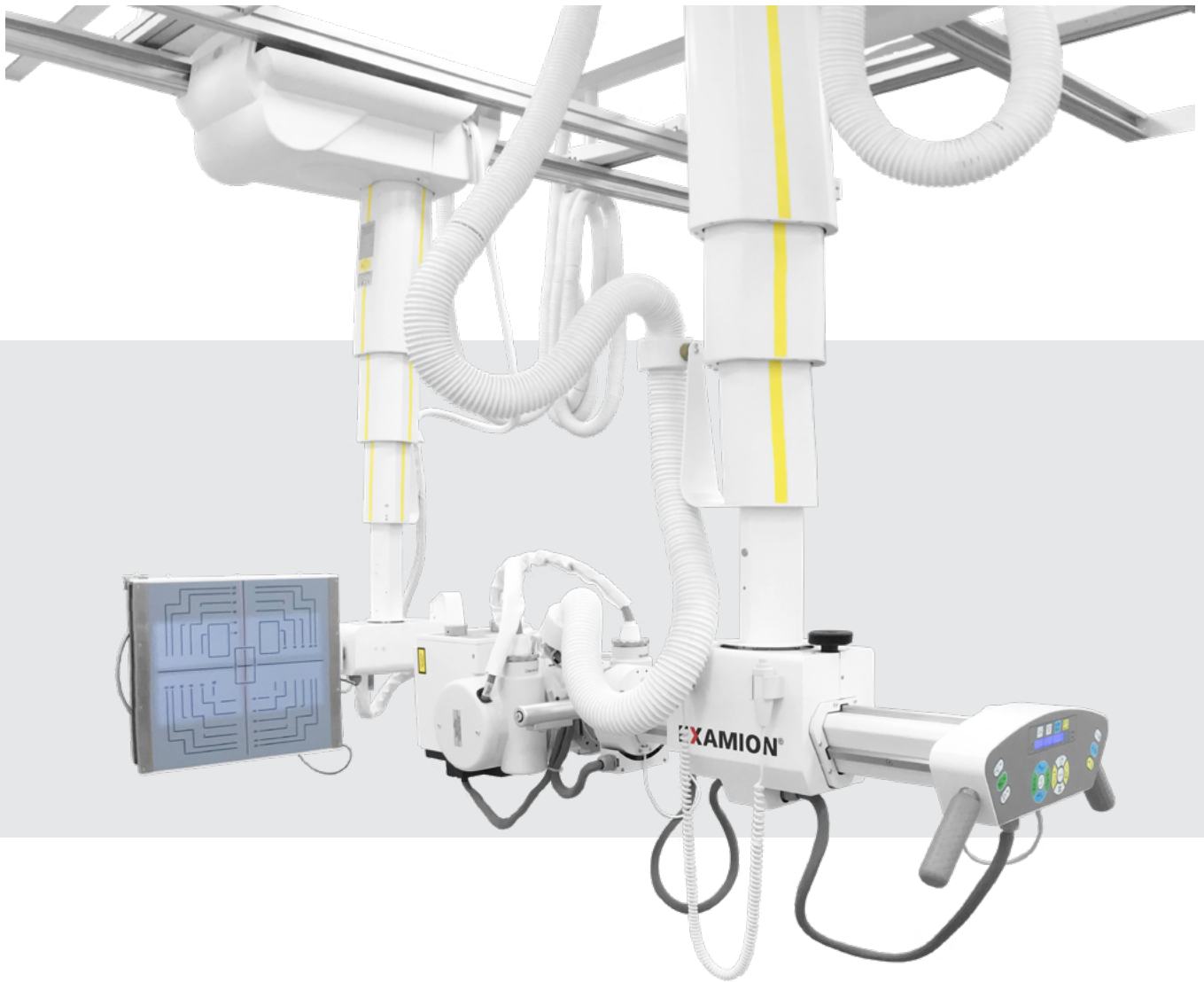

X-DRS Ceiling One

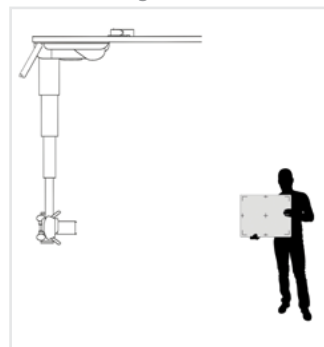

X-DRS Ceiling Two

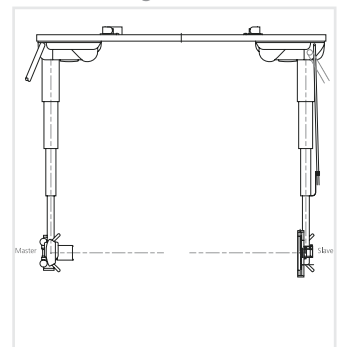



Gantry X-ray systems for Equine Clinics

Due to the combination of high generator power, telescopic arms, and EXAMION's high-quality detectors, the gantry X-DRS Ceiling X-ray System is perfectly suited for all-round radiological imaging in the equine clinic.

The X-DRS Ceiling X-ray system challenges the best radiological practice on horses' extra thickness and high-density body parts. X-ray penetration requires powerful veterinary X-ray equipment. For this, X-DRS ceiling systems are standard equipped with X-ray generators up to 100 kW power. This high performance in combination with the premium matched EXAMION detectors ensure brilliant X-ray images every time.

The stationary X-ray system can be equipped with one or two telescopic arms. The large displacement range of the telescopic arms in the ceiling rails offers the greatest possible freedom of movement throughout all your X-ray examinations.

Available types

X-DRS Ceiling One

The X-DRS Ceiling One is equipped with a single telescopic arm for the X-ray tube. High power X-ray tubes are inherently associated with the corresponding heavy weight. This is carried by the telescopic arm, maximizing relief on the X-ray system operator when performing delicate equine examinations.

X-DRS Ceiling Two

The X-DRS Ceiling Two has two telescopic arms. The X-ray detector is installed on a second telescopic arm, which can be moved in synchronization with the X-ray tube on the first telescopic arm. When the detector is positioned in its mounted bucky tray, no assistance is required to hold it in position.

Consequently, the number of people involved can be reduced, limiting exposure of personnel to X-rays. The detector tray on the second telescopic arm additionally performs the automatic exposure (AEC) function so that the X-ray acquisition process is always attained with the optimal X-ray dose.

The X-ray detector can be removed from its bucky tray and moved freely into any chosen position.

Technical specifications

Vertical mobility	180 cm height (193 cm height optional)
Ground clearance	7 cm to 13 cm
Spatial requirements	430 cm x 460 cm
Horizontal mobility of the X-ray tube telescopic arm	32 cm

Digital All-in-One Systems for Small Animals

Digital All-in-One solutions constitute fully-integrated systems essentially comprised of an X-ray device and a detector. All components of the integrated X-ray systems are controlled by EXAMION's universal X-AQS software platform, ensuring highest user-convenience and the fastest workflow.

The detector and X-ray system are perfectly matched with each other for optimum performance. As a result, you consistently get the superior image quality.

Your expert partner for X-ray systems



X-DRS – Digital all-in-one systems for small animals

Our small animal digital X-ray systems set the benchmark for image quality and ease of use. The systems were developed from the start as a complete solution, each with the aim of achieving an optimal product. The central element is our intuitive EXAMION X-AQS software, which is installed in the control workstation.



Intuitive operating system software

Our software carries species-specific organ X-ray programs. The selection of a specific organ determines X-ray exposure values, detector operation, and optimal image processing, as well as the proper labelling of the X-ray image. All settings are entered with just one click, and the X-ray image is displayed within a few seconds.

The X-ray viewer display function is fully integrated within the control workstation via the software platform. This enables viewing and evaluation directly from the device. All measurement functions are also readily accessible.

The permanent image file archive can also be integrated within the control workstation. If you already have an image archive, this can be easily linked to the system via the DICOM interface.



Highest image quality

The detector's advanced cesium iodide technology, its optimal coordinated with the X-ray system, and EXAMION's advanced image processing capabilities, combine to maximise image quality.

The MetaGrid software module is used to suppress so-called scatter radiation. Scattered radiation can lead to a loss of contrast and detail, i.e. to lower image quality. This can now be easily eliminated using state-of-the-art scatter reduction algorithms. Grids placed between the subject and the x-ray film used to be used to reduce the scattered radiation reaching the detector and thus improve image contrast.

Furthermore the disadvantage of the grid is that it requires an amplified radiation dose for each exposure. MetaGrid modular software not only increases image quality, but also offers enhanced radiation protection for operators.

X-DR Static Classic





All-in-one X-ray system with maximum integration

The X-DR Static Classic is designed to meet all the requirements of a small animal X-ray system for the small animal veterinary practice to the large veterinary clinic. Key features are the high performance and the sophisticated design of the system.

With its onboard computer-assisted system control, all functions are available directly from the X-ray system, effortlessly accessible via its integrated multi-touch screen. System cabling is largely contained within the device, for a high-quality aesthetic appearance, and the best possible protection for the cables.

All X-AQS software functions are readily available onboard the X-DR Static Classic:

- Cloud upload/storage option
- Forwarding via your clinic/veterinary practice email

Image viewing:

- Diagnostic tools and measurement functions

File sharing:

- Patient CD
- Export to USB drive

Image archive:

- The EXAMION image archive can also be optionally integrated into the system.

All functions can be effortlessly controlled via the integrated multi-touch monitor.

The system is wall socket plug-in compatible. No special power connection is required for installation.

Technical specifications

Generator output power	32 kW / max. 450 mA
Voltage range	40 kV to 125 kV
Capacitor technology	Standard socket connection, 230 V (capacitor technology to achieve performance values exceed those of a wall socket connection)
X-ray tube	Monoblock, focus 0.6 mm / 1.3 mm
Exposure time	1 ms to 2.5 s
Preset organ programming:	352 pre-installed
Tabletop	160.6 cm x 77.6 cm, floating longitudinal range +/-35 cm, transverse range +/-11 cm

X-DRS Floor Basic



Optionally with wall stand





Top cost-performance small animal X-ray system

The X-DRS Floor Basic was developed as a high-end X-ray system specifically to meet the needs of small animal veterinary clinics where radiological imaging is fundamentally crucial. The main features of the system are its extremely high performance capabilities and its extra-large yet flexible X-ray table.

The X-DRS Floor Basics workstation is an independent unit, allowing adaptable location, both in the X-ray room and in a separate control room.

Superior performance

The X-DRS Floor Basic comes with its high +50KW generator power, bringing significant reductions in the x-ray exposure times, eliminating patient and organ movement with increasing image sharpness for your delicate cardiovascular and thoracic X-ray imaging.

The X-DRS Floor Basic easily performs any high-volume X-raying required. Its high thermal capacity ensures consistently reliable performance when it matters.

Maximum positioning possibilities

A main feature of the system is the extra-large X-ray tabletop with 4–6-dimensional BT movement flexibility. Despite its size, it can easily be manoeuvred into the optimal position for examinations. In addition to the floating tabletop, the X-ray tube is also movable, providing multiple options for setting up the desired exam position.

Its X-ray tube and the detector tray on the X-ray table are mechanically coupled, the two always align accurately with each other.

Optional: The additional wall stand allows for easy imaging animals in standing position, the X-ray tube easily swiveled into position towards its wall bucky stand.

Technical specifications

Longitudinal range of the X-ray tube	136.5 cm
Vertical range of the X-ray tube	127.6 cm
Vertical range wall stand (centrally from X-ray base)	Min.: 40 cm Max.: 176.5 cm
Tabletop dimensions (LxW)	228 cm x 80.6 cm
Tabletop height	70 cm
Range tabletop	Longitudinal: ± 50 cm Transverse: ± 8.5 cm
Load tabletop	Max. 250 kg in prone position

X-ray system for small animals

If you are looking for a high-performance system for your small animal practice (that is, a fully-integrated combination of an X-ray system and a detector, instead of an all-in-one digital system), we can offer a reliable, tried-and-tested solution.

Your expert partner for X-ray systems



X-R Static Univet

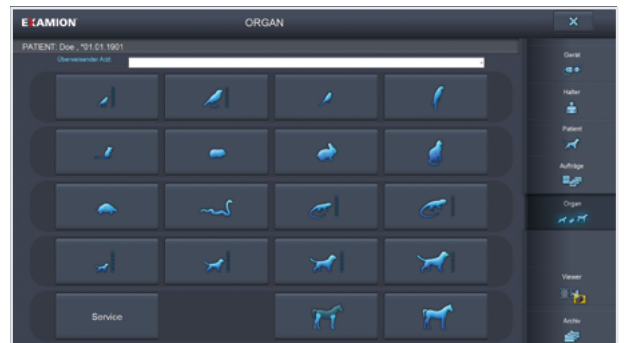



The cost-effective X-ray system for veterinary medicine

The X-R Static Univet is a cost-effective versatile high-frequency X-ray system that delivers high-quality radiographs.

The X-R Static Univet is available as standalone and as a complete system solution with an EXAMION CR system or DR system. The system can even handle X-ray film cassettes for classic X-ray films, if required.

Features

- The X-R Static Univet can be installed quickly, conveniently and safely.
- Equipped with 352 standard organ programs to ensure convenient and user-friendly handling.
- Animals can be positioned comfortably on the floating tabletop with electronic brakes for examination.
- Despite its floating tabletop and high output capacity, the system is remarkably compact.
- The X-R Static Univet system includes a customized version of our EXAMION X-AQS software that permits intuitive tasking of the X-ray parameters.

Technical specifications

Generator output power	30 kW / 400 mA
Voltage range	40 kV to 125 kV
Capacitor technology	Standard socket connection, 230 V Capacitor technology to achieve power values exceeding wall socket connection capacity
X-ray tube	Double focus, focus 0.8 mm / 1.8 mm
Preset organ programming:	352 pre-installed
Tabletop	160 cm x 68 cm, floating, operated electrically via foot pedal, longitudinal range +/-28 cm

Dental X-rays

EXAMION offers the full range of optimally matched components for dental X-rays: On the one hand, an X-ray system tailored to the needs of the veterinary practitioner, and on the other hand, a flexible, fast imaging plate system for image development.

Dental treatment often requires a full set of dental X-rays spread over several exposures. With this in mind, it is clearly advantageous if the individual images can be exposed and read together seamlessly, i.e. rapidly, one image after the other.

Your expert partner for X-ray systems



X-R Static Dental HF wall / mobile

X-R Static Dental HF wall



X-R Static Dental HF mobile



X-R Static Dental HF mobile





Small animal dental X-ray generator

The X-R Static Dental HF X-ray system is characterised by its high performance and reliability, enabling accurate acquisition of X-ray images. The Dental X-ray generator can be supplemented with the corresponding digital dental readout system, such as the EXAMION X-CR More Tabletop FireCR, which quickly and cost-effectively provides high-quality dental images for veterinary dental clinics.

Protection: The X-R Static Dental HF X-ray generator provides better patient protection with its X-ray tube directly on the back of the tube-head. Its dose filtering process and excellent control of radiation leakage contribute to the safety of the user, while the control knob ensures that the radiation doses delivered to the patient remains constant.

Movement: The hinged arm provides optimum movement along with precise positioning. It is also easy to maintain and disinfect.

Intelligence: The new control panel makes the system fully safe and easy to use. Features include automatic diagnosis on the control panel, control of electrical parameters via the timer and automatic compensation of the exposure according to in the line voltage

fluctuations.

Reliability: Known for its reliability and precision, the X-R Static Dental HF X-ray generator is designed in one piece and made from a light alloy. Built using the double chamber-technique, the first part contains the x-ray tube with dielectric oil and the second contains the electronic components.

Ergonomics: Patented timer includes new technology capable of recognizing the exact type of generator connected. User-friendly control panel with recordings that can be personalized and programmed.

Technical specifications

Tube voltage	60 kV / 70 kV
Tube current	4 mA / 8 mA
Exposure time	20 ms – 3.2 s (23 increments)
X-ray tube	Focus 0.7 mm
Wall arm sizes available:	40 cm, 80 cm, 110 cm

-CR More Tabletop FireCR Dental





CR Imaging plate scanner for intraoral dental X-rays

The full-featured X-CR FireCR dental reader delivers high-quality dental images quickly and affordably for the veterinary clinic.

The X-CR Tabletop FireCR affordable and compact veterinary dental solution immediately enhances dental x-ray work in your veterinary practice. Its rapid, high-quality reading of reusable, easy-to-position bitewing, intraoral imaging plates, generated high quality dental X-rays.

The two-step process of X-CR More Tabletop FireCR may take slightly longer, but it also has significant advantages:

- The special image plates themselves are very thin, durable and resilient. This makes them very easy to position intraorally.
- Dental image plates are available in different dental sizes for different animal species and body regions.

At 12 cm wide and 32 cm high, the X-CR FireCR dental reader is compact and suitable in even the most cramped veterinary offices and examination rooms.

The magnetic feed of the X-CR Tabletop FireCR has several advantages:

- No additional adapters are required to read the imageplate. Image plates are placed directly on the feeder and held in place magnetically. This ensures a fast workflow.
- During the dental image read-out process, the plate itself is not bent or touched by the rollers as it moves through the feeder. This ensures a longer life cycle for the image plates before they need replacement.

FireCR image plate sizes

Size 0	(22 mm x 31 mm) 628 px x 885 px
Size 1	(24 mm x 40 mm) 685 px x 1.143 px
Size 2	(31 mm x 41 mm) 886 px x 1.171 px
Size 3	(27 mm x 54 mm) 771 px x 1.542 px
Size 4c	(48 mm x 54 mm) 1.370 px x 1.542 px

Portable X-ray generators

EXAMION's portable X-ray generators provide essential support for mobile veterinary practitioners during patient visits. If you perform X-ray examinations exclusively or predominantly in the field, you need sturdy equipment that is inherently flexible and known to be reliable. Our portable X-ray solutions fully meet these requirements and can be conveniently operated via the hand switch.

In combination with our battery-powered mobile DR case solutions, you benefit from a fully portable X-ray system as a perfectly coordinated complete system.

Your expert partner for X-ray systems

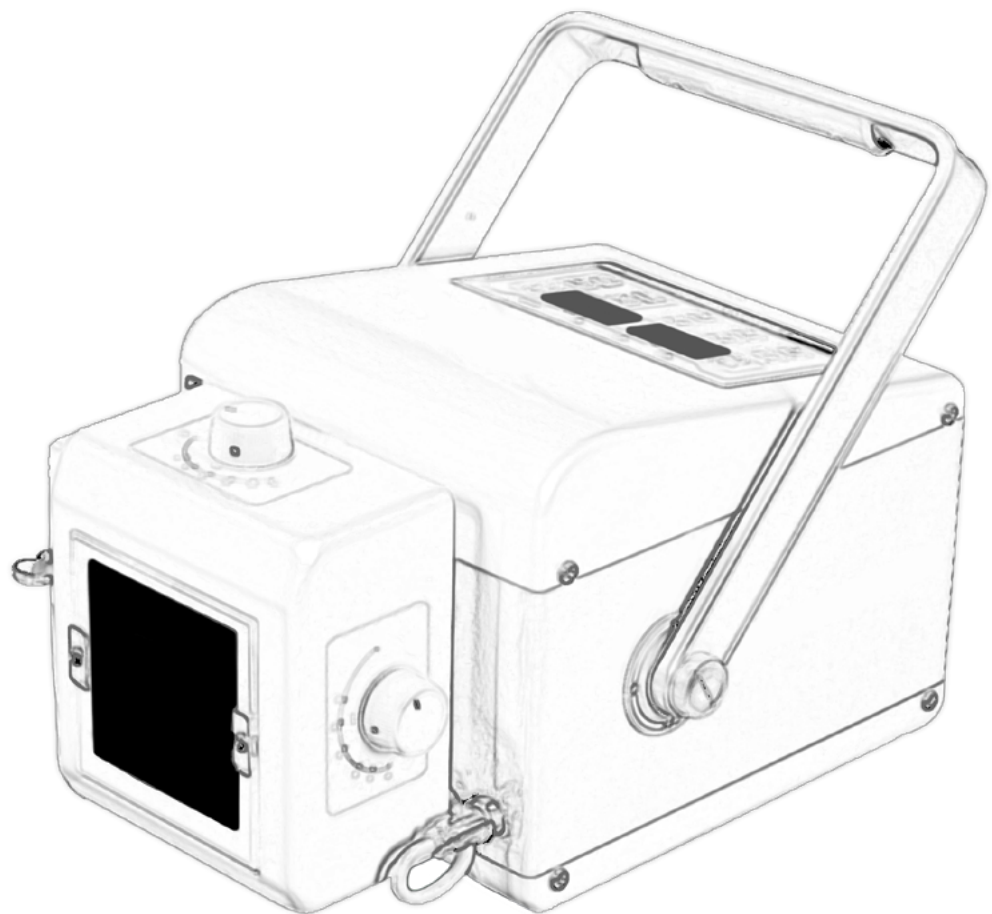

X-R Portable – battery-powered devices





Lightweight and easily portable for in field use

The EXAMION battery-powered X-R Portable X-ray generators are the most suitable portable X-ray generator for mobile radiological applications with horses and large animals.

Low weight, high power with dual laser pointer and 8 memory keys makes this portable X-ray generator the perfect companion in your everyday all-round x-ray work. The generators are equipped with small focal point for highest resolution imaging, built-in bubble level, on-board dual laser pointer and tape measure. Furthermore for transport they are protected by a robust housing and carrying case.

Available types

X-R Portable 20 BT

The X-R Portable 20 BT is the most compact X-ray generator in its range. With its sharp focus and low weight, it shows extreme stability in its high mobility around the horse, which improves overall image quality during high volume X-ray examinations.

X-R Portable 20 BT Plus

The all-round choice for continuous X-raying. Its best weight, power ratio makes this portable X-ray generator the perfect companion in your everyday all-round X-ray work.

X-R Portable 40 BT

The X-R Portable 40 BT is the perfect choice for optimum power in the portable range.

Technical specifications

	X-R Portable 20 BT	X-R Portable 20 BT Plus	X-R Portable 40 BT
Weight	7.2 kg	11.2 kg	12.8 kg
Max. output	1.6 kW @ 80 kV	1.6 kW @ 80 kV	2.4 kW @ 80 kV
Power	90 kV / 20 mA	100 kV / 20 mA	100 kV / 35 mA
Voltage	50 kV bis 90 kV (1 kV increments)	40 kV to 100 kV (1kV increments)	40 kV to 100 kV (1kV increments)
mAs	0.4 mAs – 20 mAs (25 increments)	0.4 mAs – 100 mAs (32 increments)	0.4 mAs – 100 mAs (25 increments)

X-R Portable - Cable connection devices



X-R Portable 20 Plus



X-R Portable 40





Perfect X-ray generator for mixed animal practices

The X-R corded series is the most practical method for everyday mixed clinical and mobile radiological applications with horses and small animals.

Do you work primarily out of your veterinary practice, but occasionally need mobile X-rays? Then our portable X-ray machines equipped with cable connection are the perfect solution. With cable connection to the mains, there is no risk of running out of battery in an emergency and the system is ready in stationary and mobile use.

Available types

X-R Portable 20 Plus

Its best weight, power ratio makes this the most portable X-ray generator the perfect companion in all-round X-ray work.

X-R Portable 40

The X-R Portable 40 is the perfect choice for optimum power and sharpest detail in the mobile mixed practice range.

Technical specifications

	X-R Portable 20 Plus	X-R Portable 40
Weight	9.8 kg	12.8 kg
Max. output	1.6 kW @ 80 kV	2.4 kW @ 80 kV
Power	100 kV / 20 mA	100 kV / 35 mA
Voltage	40 kV to 100 kV (1kV increments)	40 kV to 100 kV (1kV increments)
mAs	0.3 mAs – 50 mAs (22 increments)	0.4 mAs – 100 mAs (25 increments)

Portable case solutions

We have developed two high-quality EXAMION detector case solutions ideally suitable for mobile practitioners, and especially equine radiologists. The systems are extremely compact and ready for use in no time. The main difference between the two systems is the detector size.

Our carrying case solutions are ideally complemented by a battery-operated portable X-ray generator (see pages 30-31).

Your expert partner for X-ray systems

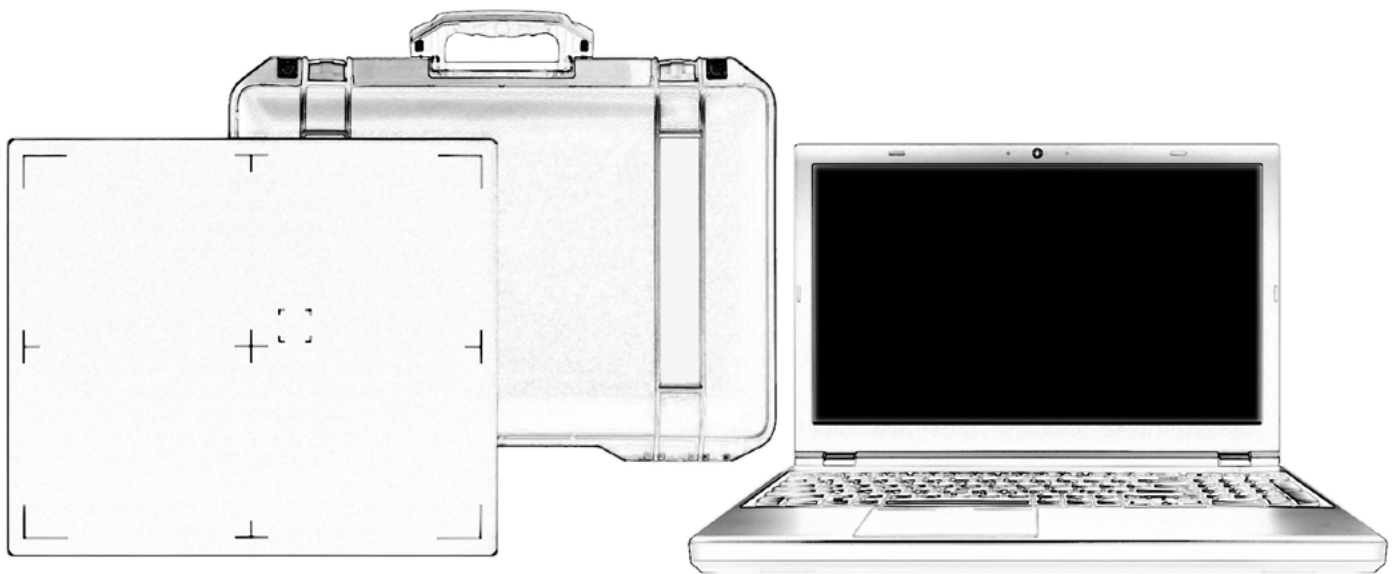

X-DR Case solutions

Our portable case solutions consist of optimally matched components. The two most essential pieces of equipment, the detector and the laptop, are accompanied by the necessary accessories e.g. batteries, charger. The case solution accommodates all system components.



The system is ready for use in a few seconds and quick to operate. You can concentrate on the animal you are examining without the distraction of having to follow complicated system operating procedures. Operating our software requires a minimal number of clicks.

- Special workflow for equine exams. No inputs need to be made on the Ultrabook between individual image acquisitions. You can stay focused on the horse, with visual and acoustic signals indicating when the system is ready for the next exposure (after only a few seconds).
- Equine-specific organ programs with optimal organ image processing, in just one click.
- Short-cut buttons generate complete organ exam lists with just one click, for example, in the case of equine pre-purchase exams.

The advanced cesium iodide scintillator technology of our detectors and sophisticated EXAMION image processing features provide Superior quality radiological images with optimal resolution for display on the laptop's specially calibrated screen.

Our detectors are equipped with AED Sensor (automatic exposure detection). The detector recognises incident X-rays automatically and starts recording the X-ray image without the need any further external signal from a remote handset, for example. Detector and laptop communicate directly. In an emergency or when space is limited, you only need these two items plus the X-ray device to perform an X-ray exam.



Your expert partner for X-ray systems



Detector and laptop communicate directly. Beside the portable X-ray unit, you only need the flat panel and laptop for a complete examination. Perfect for operating in all conditions.

The laptop workstation can be operated with a click or touch on its multi-touch screen, via keyboard, or touchpad.

As a complete integrated solution, our proprietary X-AQS software provides fast image acquisition, and many essential functions through its single common interface:

- Easy X-ray image diagnostics via our on-board radiology viewer with diagnostic tools and measurement functions
- Integrated image archiving with direct access to all archived X-ray images and patient data
- Sharing X-rays with clients and colleagues via the integrated X-AQS dropbox cloud module

-DR Portable Case L WiFi





Universal mobile solution

This portable X-ray case is equipped with our L-Format detectors, the active surface of the detector has the dimensions of the standard 35 cm x 43 cm (14 in x 17 in) film, the most used format for medical detectors.

The X-DR Portable Case L WiFi has all the benefits of a mobile detector system at its best value. The X-ray case is totally portable, suitable for use in field and veterinary clinic.

The L-size is ideal for examining large and small animals. The detectors can be used in combination with existing X-ray systems. When you need to perform animal x-ray examinations outside the clinic, simply remove the detector from the cassette drawer of the x-ray table and store it securely in the supplied rugged X-ray case. It is easy to transport together with the laptop workstation.

Soft travel pouch specially designed for easy transport of the detector, available on request.

Technical specifications

Case dimensions (L x W x D)	590 mm x 525 mm x 225 mm
Case total weight (fully equipped)	<18 kg
Pixel matrix detector	2.304 px x 2.800 px
Transmission time detector	5 sec
Detector synchronization	AED (Automatic Exposure Detection)/external trigger
Detector battery	Type: Lithium polymer Loading time: 2 hours Battery life (single battery): 4 hours for 200 images Lifetime: min. 1,000 cycles

X-DR Portable Case M WiFi DT





Specialised X-ray system for equine radiologists

The M format detectors are based on the standard X-ray film format 24 cm x 30 cm. Compared to L-size detectors, this has several advantages, particularly for equine radiologists who do a lot of X-rays:

- Due to the smaller dimensions and lighter weight, handling and operation during equine exams is faster and easier.
- The detectors also need a relatively small storage/travel case, meaning that portability of the system can be enhanced even further, if the lighter option is preferred.

The X-DR M WiFi detector ensures high-resolution radiological images for brilliant image quality thanks to the smallest pixel size of only 76 microns.

The system comes with a soft carrying case or a hard case.. This means even more flexibility with regard to transporting the device.

The integrated control display of the detector shows current status information at all times.

Technical specifications

Case dimensions (L x W x D)	508 mm x 373 mm x 147 mm
Case: total weight (fully equipped)	<11 kg
Pixel matrix detector	3.072 px x 3.840 px
Detector synchronization	AED (automatic exposure detection)
Detector battery	Type: Li-ion polymer Loading time: 3 hours Battery life: 3.5 hours (at full acquisition); approx. 630 cycles (with full charge from fully discharged, 1 cycle)

Imaging plate systems

Imaging plate (IP) systems, also known as CR systems, represent the ideal entry-level systems for digital image processing. They can be easily combined with virtually all existing X-ray systems.

In contrast to detector systems, also known as DR systems, which transmit the X-ray image directly to the computer control unit, readout requires additional steps.

Your expert partner for X-ray systems



X-CR Systems for digital X-ray



X-CR Tabletop Sigma



X-CR Tabletop HighCap





CR systems for digital X-ray

EXAMION imaging plate systems are a cost-effective variant for digital X-ray. In contrast to detectors that transmit the X-ray image directly to the computer control unit, imaging plate systems require several steps. First, the imaging plate cassette is exposed by the respective X-ray system, then it is placed into the image plate scanner, and the image plate is automatically extracted by the scanner, for readout.

Image plate systems are suitable if time pressure in the working medical practice setting is not that heavy, and therefore any relative delay in acquiring the X-ray image, due to the more complicated read-out process, is hardly significant.

The systems can be easily combined with all existing X-ray systems, provided that the preferred 35 cm x 43 cm cassette format fits into the respective cassette tray.

The approximate throughput of the available systems is 60 cassettes in 35 cm x 43 cm format per hour. The time required to read the imaging plate cassettes is compensated for to a certain extent by the fact that, in addition to the 35 cm x 43 cm size, there are also smaller cassette sizes available, for which the reading process can be completed somewhat faster.

EXAMION's X-AQS software includes a special operating mode designed for image plate scanners. Clicking on 'Start' in the software program initiates the respective reading process.

This software version offers the same performance as our standard version in terms of image post-processing and evaluation, that is, it can carry out the full range of functions. If you subsequently decide to switch from an imaging plate system to a digital detector system, our software remains virtually the same. Very little extra training would be required.

Our imaging plate scanners are desktop devices, among the most compact in their category.

The EXAMION portfolio includes a range of image plate systems. Please contact us for more details, we will be happy to assist you.

Detectors

Our X-DR series detectors can be used to digitise stationary systems, as well as mobile and portable X-ray systems. Our customised retrofit solutions typically consist of a suitable detector and our X-AQS software. With just these two quick-to-install elements, you have an efficient X-ray system right at your fingertips.

Your expert partner for X-ray systems

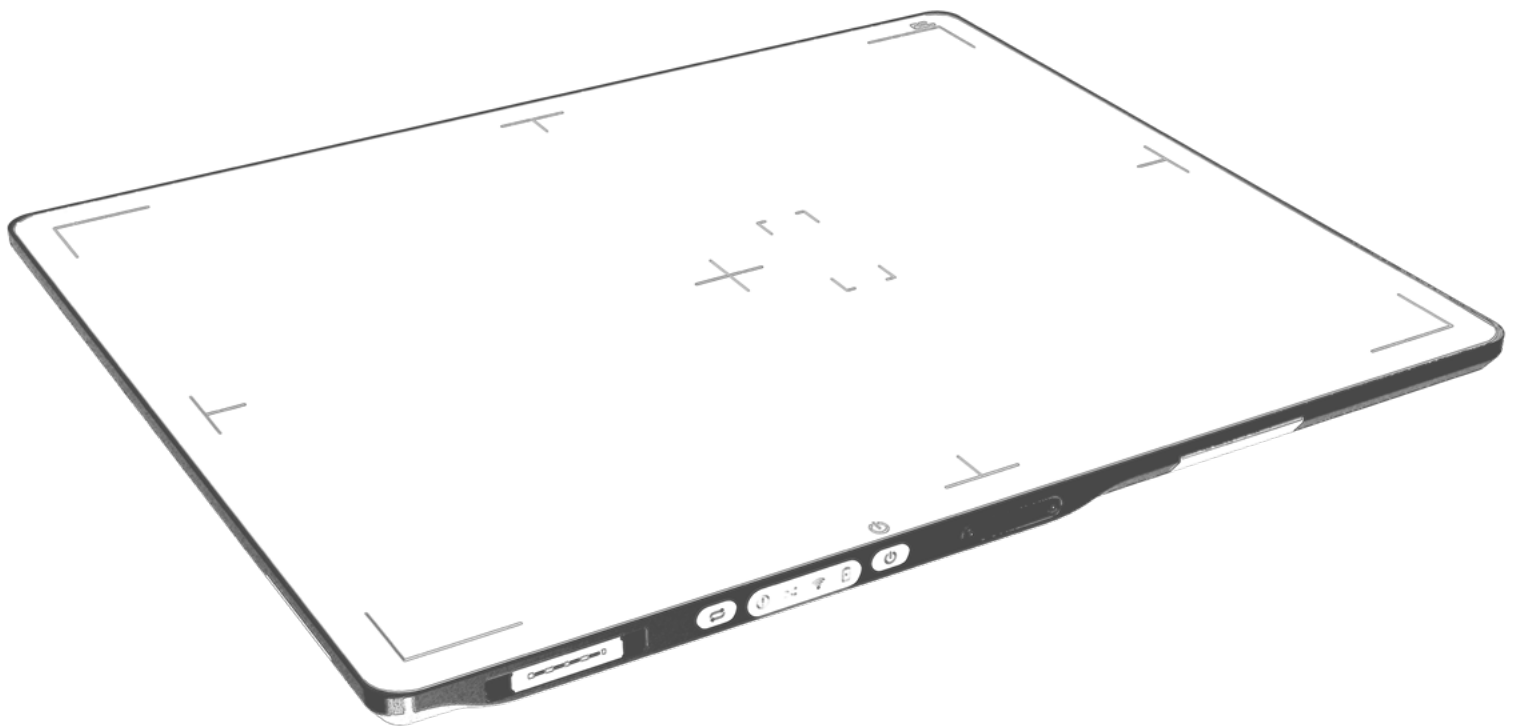

X-DR WiFi – detectors in different sizes

The detectors are the same size as classic X-ray cassettes, so they can easily be retrofitted into existing systems. In addition, they are suitable for all the X-ray systems presented in this brochure.

EXAMION detectors are at the heart of the majority of our X-ray solutions. They ensure maximum image quality and increase your workflow speeds:

- Advanced cesium iodide scintillator technology provides high resolution and low image noise.
- The detectors transmit the image directly to the control station computer with no additional steps needed. This offers you the quickest way to capture an X-ray image.



Data is transmittable via WiFi and power can be supplied by rechargeable battery. If the detector is installed in a permanent location, then the corresponding power supply cable is also available as an option.

For stationary X-ray systems with two workstations – usually bucky table and wall-mounted unit – various options are available:

- A single detector can be used either in the bucky table or wall stand, as needed.
- In case of a two-detector solution, both the tabletop bucky tray and the wall-mounted device are equipped with their own detector. This avoids time-consuming swapping out of the detector between the tabletop and wall-mounted device.

There are three areas of application for our detectors:

- Our fully digital all-in-one X-ray systems are equipped with these detectors. Thus, the detectors are optimally integrated into the system. For a smooth workflow, all components are perfectly matched.
- Together with a laptop our detectors become a lightweight and flexible carry case system for mobile applications.
- Existing X-ray systems can be retrofitted with our detectors (retrofit systems).



Your expert partner for X-ray systems

Our most popular models at a glance

	X-DR L WiFi	X-DR L WiFi Premium	X-DR XL WiFi	X-DR XL WiFi Premium
Pixel pitch	150 µm	100 µm	139 µm	100 µm
Pixel matrix	2.304 × 2.800	3.500 × 4.300	3.072 × 3.072	4.267 × 4.267
Weight	3.4 kg	2.8 kg	4.6 kg	3.4 kg

X-DR XL

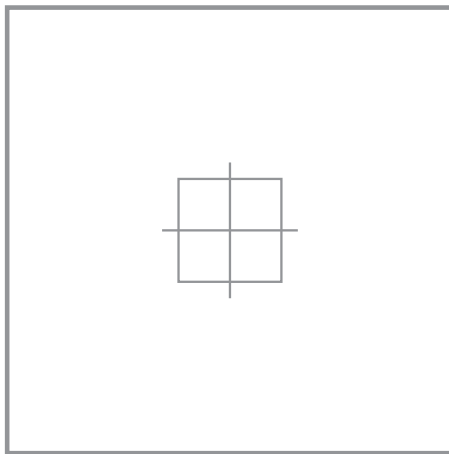

43 cm (+/-2 cm)

X-DR L

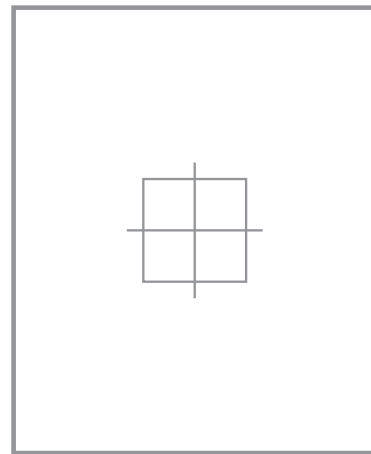

35 cm (+/-2cm)

43 cm (+/-2 cm)

X-DR L WiFi and X-DR XL WiFi

Our bestselling product offers superior value for money. One special feature of these detectors is their excellent image quality, satisfying even the most demanding specifications.

X-DR L WiFi Premium and X-DR XL WiFi Premium

Our premium X-ray detectors are characterised by their lightweight design and high IP protection rating against ingress of fluids. Due to their low pixel size of only 100 µm, they provide X-ray images of optimum quality that satisfy even highest demands.

One-Stop-Shop & Service

With EXAMION as a partner able to offer solutions for all the issues affecting your specific practice, you benefit from a one-stop shop provider with long-standing experience. We provide comprehensive support for X-ray equipment, components, accessories and digital X-ray systems. With the comprehensive customer service provide, we are at your side from the planning stages through to installation and after.

Our tried-and-tested modular approach will always give you the opportunity to find the best fit solution to meet the demands of your specific practice or clinical setting.

Your expert partner for X-ray systems



X-AQS Software – Acquisition, control, archiving

EXAMION X-AQS software provides a universal solution for X-ray image acquisition, processing and archiving, giving you control over a wide range of CR digitisers, DR detectors, X-ray generators and processes. The software is available in DICOM modality format, for connection to your existing image archive, and also as an X-AQS PACS system solution, with the same standard operation at viewer workstations.

The software can be adapted and expanded to meet your growing needs.

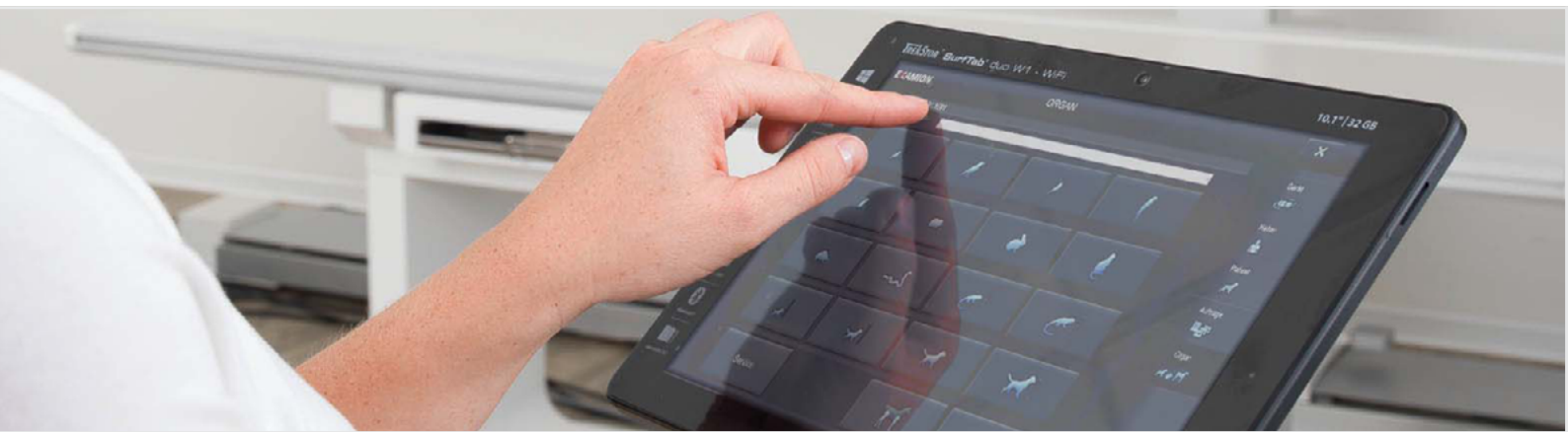

Version 1:

X-AQS with DICOM modality for connection to an existing image archive.

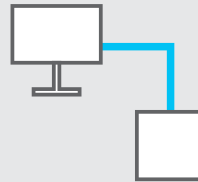

Version 2:

System solution with X-AQS PACS with integrated access even from viewer workstations.

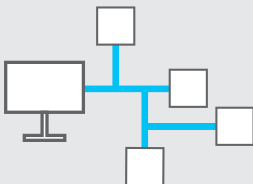

Version 3:

X-AQS hybrid model with local image mini-archive & additional storage in central archives.



Our proprietary X-AQS software with its impressive user-friendly interface serves as the central control unit for digital X-rays. Simple, self-explanatory buttons enable the acquisition of perfect X-ray images with just a few clicks.

We offer you a future-proof universal software platform that continues to be improved and developed and is subject to continuous testing by users.

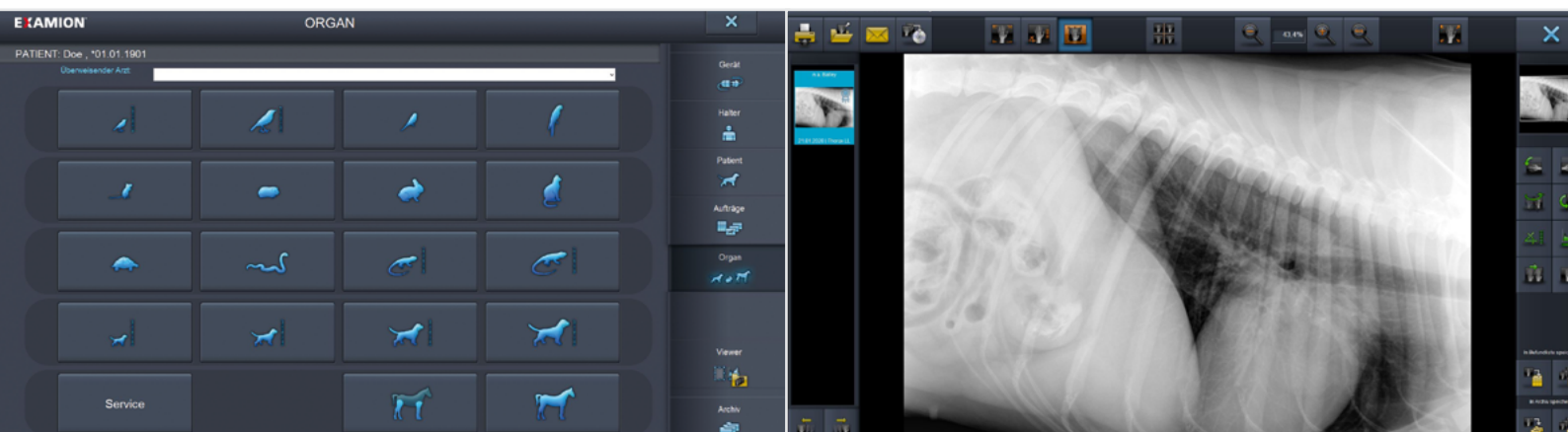

System instructions

Full touchscreen operation – Specific selection of animal species – Freely editable organ lists per animal species

Image acquisition

State-of-the-art X-AQS image processing – Consistent operation with different image sources, even when switching between CR and DR systems – Digital X-ray log

Post-processing

Export to DICOM and other formats via USB stick, DVD and email – Extensive image post-processing functions – Measuring tools already available from the acquisition workstation

Additional functions with the X-AQS image archive

Client software for any number of viewer workstations – Integration of peripheral devices, e.g. ultrasound, endoscopy, CT and MRI

Web client

Full-featured web client not only for image viewing, but also capable of handling patient management and order placement

X-Services – We're here for you!

Our sales and service network is constantly expanding, so we can make sure that we are never too far away. This means we can be here for you throughout: during planning, installation and afterwards, with our full range of post-sales services. We also have you covered if you need assistance with relocation, expansion or modifications to your medical practice or clinical setting.



Consulting

EXAMION complete X-ray systems are able to meet even the most demanding conditions and specifications. Our expertly-qualified sales representatives will be happy to advise you. You can find us at trade fairs or call to arrange an appointment at your own facility.

Together we can create a customised solution with the appropriate hardware components and software modules to suit your needs.

Installation, maintenance, repair

With their extensive know-how, our technicians guarantee smooth operational commissioning into service of your new X-ray system when your devices are installed.

We ensure that the right maintenance schedules are in place, in particular for heavily-used X-ray systems. In the event of a malfunction, you benefit from our nationwide service team.



Hotline

For quick and easy routine operations, our professional support team can be contacted directly and respond directly to your issues – either by telephone, remote maintenance or by immediate dispatch of a field service technician.

Temporary solutions

Until repairs and full restoration take place, we will provide the assistance you need to ensure that you don't have to worry about prolonged downtimes, even in case of system defects.

We are committed to our customer's satisfaction. All of our departments work hand in hand to achieve this goal.

Your expert partner for X-ray systems







Notes

EXAMION GmbH

EXAMION is a global provider of digital radiography solutions for human and veterinary medicine. For more than 30 years we have been guided by our credo "One Stop Shop & Service" and are available to our customers as a competent partner for planning, installation and after-sales services.



Our advice on technical and commercial questions is always based on the individual customer's respective requirements and the circumstances facing their particular medical practice or clinic. Each product purchase quotation is individually prepared by our experts with the specific customer in mind.

We currently service more than 7,000 systems, most of which are permanently installed in clinics and medical practices, the remainder being portable systems for mobile applications. The proprietary EXAMION X-AQS software for device operation, image processing, evaluation and archiving standardises operation and control, and ensures workflow efficiency. In addition to digital radiography, our product portfolio includes digital imaging systems as well as systems for mammography and X-ray therapy.

More than 150 employees work together with our customers throughout Germany. We also maintain a presence at four other European locations; in Belgium, Poland, Portugal and Switzerland. We also collaborate with a constantly growing network of service and sales partner companies worldwide.

Take advantage of our long-standing experience

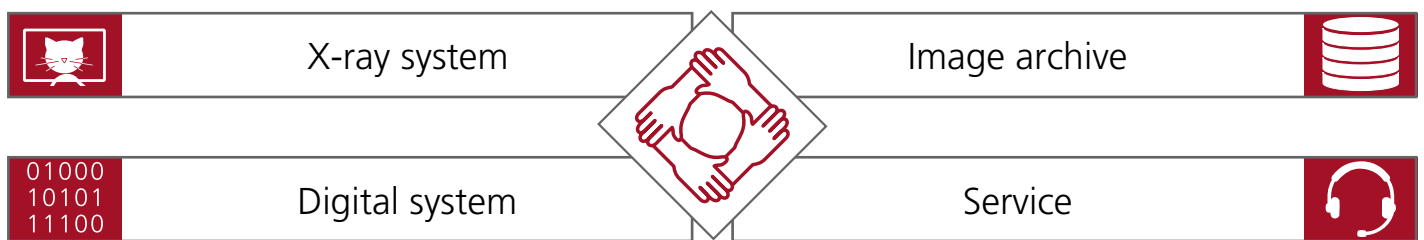



Your local sales and service partners

Contact

EXAMION GmbH
Erich-Herion-Straße 37
70736 Fellbach, Germany

www.examion.com

 +49 (0) 711 120 002 - 0

 +49 (0) 711 120 002 - 22

 vertrieb@examion.com



Certified partner of EXAMION